

DGOZ-SEN-PRLLSW / DGOZ-SEN-PRLLSW-BK

**RAPIX DALI-2 Occupancy/Presence/Light Level Sensor
 With Auxiliary Input and Application Controller**

Suitable for direct connection to a DALI line for sensing, switching, dimming, timing, group and scene control and similar functions.

Product summary and capabilities

This product acts as an occupancy (presence) sensor, light level sensor, and push button switch input device, powered directly from the DALI line.

The sensor works with DALI-2 Application Controllers and exposes 3 instances. The sensor can also act as a RAPIX DALI Application Controller and can perform sensing, switching, dimming, timing, group control, scene control and similar functions. The sensor may have a separate voltage free switch connected, allowing additional push button control.

The sensor is commissioned using any DALI-2 commissioning software that supports instance types 1, 3 and 4. For the higher resilience of RAPIX and to set up the built-in Application Controller, use *RAPIX Addressing* or *RAPIX Integrator* software. These software packages are available at no charge from ozuno.com



Important notes and safety information



WARNING – Electric shock may result in serious injury or death. Follow all warnings in this guide and on the product. Work in accordance with the latest electrical safety practices.

- This Sensor is powered only from DALI.
- DALI system wiring is only single insulated from mains. Treat DALI wiring the same as mains wiring.
- The Auxiliary input wiring has no isolation from DALI. Treat the Auxiliary input the same as mains wiring.
- **The Auxiliary input does not provide any power source. Connect it only to voltage-free (dry) contacts or a switch. Do not connect any part of the Auxiliary Input to any other power source, or to earth, or to mains line or neutral.**
- There are **no user serviceable parts** inside the Sensor. Do not attempt to disassemble or operate the device with any covers removed.
- This Sensor is intended for **indoor use only**.
- Available in both white and black (-BK) versions.

Indicators







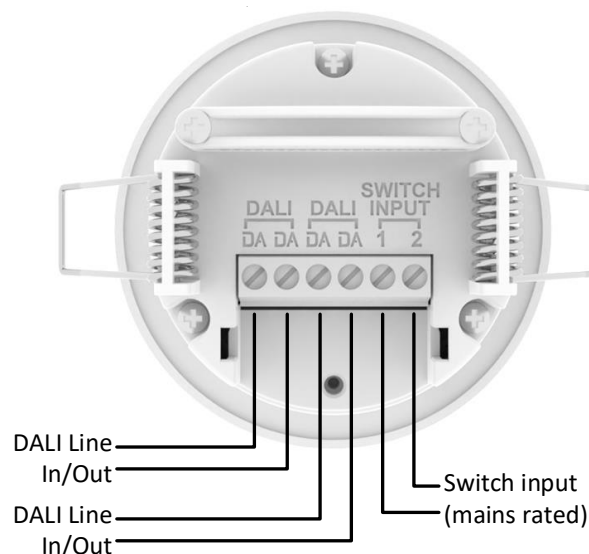

An indicator is located under the PIR lens. This will flash green when DALI-2 or RAPIX commissioning software activates the identification function. This allows physical location of the sensor after it has been installed.

This indicator will also light solid green (no flashing) to show that the sensor has not been commissioned using DALI-2 or RAPIX commissioning software or the RAPIX Zero-Commissioning processes.

Terminals



Specifications

Sensor	
Detection Range (diameter)	Major motion: 8 m (nominal, for mounting at 2.4 – 2.7 m ceiling height) Minor motion: 4 m (nominal, for mounting at 2.4 – 2.7 m ceiling height)
Light Level Measurement Range	0 – 65000 lux
Power Source	DALI line
Compatibility	DALI and DALI-2
DALI Line Capacity	Connects to 1 DALI line
DALI operating voltage	16 V dc (nominal), operation from 9.5 V – 22.5 V
DALI Line Current Draw	2 mA
Mains Tolerance	DALI input and auxiliary input are mains voltage tolerant
DALI Connection	4 Tunnel Terminal block Each tunnel suitable for 1 x 2.5 mm ² or 2 x 1.5 mm ² wires
Auxiliary Input Connection	2 Tunnel Terminal block Each tunnel suitable for 1 x 2.5 mm ² or 2 x 1.5 mm ² wires
Maximum Auxiliary Cable Length	25 m – when using twin core mains cable ≥ 0.75 mm ² wires
Auxiliary Input Types	DALI-2 Type 1 (Push button switch), Type 2 (Absolute / toggle switch) or Type 3 (voltage free contacts of an occupancy sensor). Changing instance type requires use of RAPIX Addressing or Integrator software.
Indicators	Identification: 1 x green, front through sensor lens
Ambient Operating Temperature	0 to 50° C
Ambient Storage Temperature	-10 to 70° C
Humidity	0% to 95% RH non-condensing
Ingress Protection	IP20
Materials	Enclosure – Flame retardant Polycarbonate
Weight	75 g
DALI addresses used	One DALI-2 Control Device Short Address, no Control Gear Short Addresses
RAPIX Application Controller DALI addressing types supported	Control Gear Short Addresses, Group Addresses, Scenes, Broadcast
Additional Addressing Types*	RAPIX Zones, RAPIX Flags, RAPIX Operating Properties
Approvals	     
* RAPIX features and additional addressing types work with other RAPIX products.	

Mounting

The equipment should be mounted at a height less than 4 metres above floor level.

Mounting Options	
In-Ceiling Mount	Mount into a 61-72mm diameter hole in the ceiling. Sensor is retained by the pre-fitted springs.
Optional Surface Mount Adaptor (order separately)	Screw the Surface Mount adaptor over a conduit box, or break out the conduit entry knockouts and screw the Surface Mount Adaptor directly to the mounting surface. Remove pre-fitted retaining springs and plastic posts from the Sensor using side cutters. Wire as normal and push Sensor into the Surface Mount Adaptor.

Separately Available Accessories

Surface Mount Adaptor	Screw mount, 50 mm and 60 mm spacings. Order code (white): DGOZ-SEN-SMH. Order code (black): DGOZ-SEN-SMH-BK.
Field of view mask	Allows limiting field of view by angle and segments. Order code DGOZ-SEN-FOV.

Commissioning Software

This product can be commissioned using any software that supports DALI-2 Control Devices (IEC 62386-103) Instance Types 1, 3 and 4.

For enhanced functions, additional resilience and to use the built-in Application Controller the free RAPIX Addressing or RAPIX Integrator software is available at ozuno.com. This software requires use of a RAPIX USB Interface or Zone Controller to connect the commissioning software / PC to the DALI line.

DALI-2 Instances

This sensor has 3 instances. Instance 0 is Type 4 Light Level. Instance 1 is Type 3 Occupancy Sensor. By default, Instance 2 is Type 1 Push Button. Instance 2 is always present. If no external switch is connected, then instance 2 will not generate events and will read as not pressed.

Auxiliary Input

By default, the auxiliary input is defined as a DALI-2 Push Button Switch (DALI-2 IEC 62386-301, Instance Type 1).

RAPIX Commissioning software uses a Template programming system, and this will automatically select an appropriate instance type for the desired function. This allows the auxiliary input to also be used for toggle type Bi-stable Switches, or the voltage-free contacts of an occupancy sensor.

RAPIX Zero-Commissioning: Out-of-box Functions

This sensor supports RAPIX Zero-Commissioning out of-box functions. All RAPIX Zero-Commissioning behaviour becomes automatically disabled when the sensor is given a DALI-2 Control Device Short Address, or when commissioned by RAPIX software.

RAPIX Zero-Commissioning behaviour for this product:

Switch input: By default this is **enabled**. A push button switch can be used on the switch input. This will:

- Transmit DALI BROADCAST FADE UP/DOWN when pushed and held.
- Transmit DALI BROADCAST ON/OFF for each push/release. When switching OFF, the motion sensor is disabled for 15 seconds to allow for an exit delay.

Motion Sensor: By default this is **disabled**. When enabled, movement will cause transmission of BROADCAST ON and start a 15-minute timer. Additional movement restarts the 15-minute timer. If the 15-minute timer expires a BROADCAST OFF will be transmitted. Multiple sensors can be used on the same DALI line.

To enable the Motion Sensor broadcast/timer function: WITHIN 15 MINUTES OF POWERING UP THE DALI LINE: Shine a very bright torch into and then away from the sensor lens 4 times until the green LED indicator goes out. The light must be shone in the lens for 2 seconds, then away from the lens for 2 seconds. The complete cycle of flashing light into the lens must be completed in under 30 seconds.

To disable the Motion Sensor broadcast/timer function: Cycle the DALI power OFF and ON 4 times. Each power cycle must have the DALI power on for no more than 10 seconds. When successfully disabled the green indicator behind the PIR Lens will be glowing. To check, wait for the power up blinking to stop.

To disable or enable the switch input: Press and hold the switch for 30 seconds continuously.

Standards and compliance

The product is designed to meet/exceed the following Australian and International standards:

EMC and Electrical Safety Frameworks and Standards

IEC/EN 55015, AS/NZS CISPR 15, AS CISPR 15
EN 55032, AS/NZS CISPR32
EN 55035
EN 61547
EN 61347-2-11, AS/NZS 61347.2.11
EN 61347-1, AS/NZS 61347.1
EN 62368-1

DALI Standards and Compliance

IEC 62386-101 Ed 2 (DALI-2)
IEC 62386-103 (DALI-2 Control Devices)
IEC 62386-301, -303, -304 (DALI-2 Instances Push Button, Occupancy Sensor, Light Level Sensor)

EU Directives

2014/35/EU Low Voltage
2014/30/EU Electromagnetic Compatibility (EMC)
2015/863 Restriction of Hazardous Substances (RoHS) in Electrical and Electronic Equipment

Product dimensions

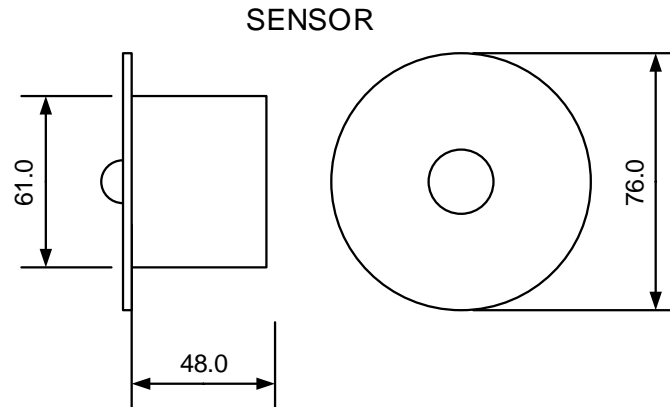

Warranty

This product has a TWO YEAR warranty against manufacturing defects. The warranty applies from the date of purchase.

Refer to [ozuno.com](https://www.ozuno.com) for the full conditions for warranty and returns process. A summary of the process:

1. Contact the seller of the goods, or in their absence contact Ozuno to request a return goods authorisation.
2. When a return is authorised, the goods must be returned to Ozuno at the owners expense for technical evaluation.
3. The warranty claim will be evaluated by Ozuno and accepted if the goods are found to be faulty, or rejected if the fault was caused by conditions beyond the responsibility of Ozuno. Considerations of installation, removal, return, freight and testing are not the responsibility of Ozuno.

The Australian Consumer Law requires the inclusion of the following statement with this Warranty:

Our goods come with guarantees that cannot be excluded under the Australian Consumer Law. You are entitled to a replacement or refund for a major failure and for compensation for any other reasonably foreseeable loss or damage. You are also entitled to have the goods repaired or replaced if the goods fail to be of acceptable quality and the failure does not amount to a major failure.



Ozuno Trading Pty Ltd (Ozuno) reserves the right to alter the specifications, designs or other features of any items and to discontinue any items at any time without notice and without liability. While every effort is made to ensure that all information in this user and installation guide is correct, no warranty of accuracy is given and Ozuno shall not be liable for any error.

Trademarks

RAPIX is a trademark of Ozuno Holdings Limited.

DALI and **DALI-2** are trademarks of the Digital Illumination Interface Alliance.

Identified trademarks and copyrights are the property of Ozuno Holdings Pty Ltd unless otherwise noted.

© Copyright

This user and installation guide is copyright to Ozuno Holdings Pty Ltd. Except as permitted under relevant law, no part of this user and installation guide may be reproduced by any process without written permission and acknowledgement to Ozuno Holdings Pty Ltd.

Sales: Ozuno Trading Pty Ltd
ABN: 96 621 194 483

Contact
support@ozuno.com

October 2023



Item 14-18-509-001-07