



Order Code	DGOZ-LRS-PRLLSW
Overview	<p>A long range / high ceiling occupancy sensor with light level measurement and switch input.</p> <p>Also includes DALI-2 Application Controller to allow advanced control functions.</p> <p>Suitable for DALI and DALI-2 systems.</p>
Features	<ul style="list-style-type: none"> • Occupancy detector and light level (lux) sensor suitable for high ceilings. • Connection to allow an external switch or voltage-free contact input, supporting push button switch, toggle switch, or the voltage-free relay contacts of an external occupancy sensor. • Connects directly to a DALI line and powered from the line. • DALI-2 Certified, multi-master. • Low current draw from a DALI line. • Very low ceiling profile. • Optional surface mounting adaptor available. • The internal Application Controller is optional, and if used: <ul style="list-style-type: none"> ○ Supports small systems, RAPIX Zero-Commissioning, and additional resilience when used in a RAPIX Lighting Control System; ○ Actions for the occupancy sensor and light sensor are configurable. Examples include occupancy mode, vacancy mode, light level maintenance, sunset switch. Fade on, fade off and dwell times are configurable; ○ Actions for the switch input are configurable. Examples include toggle dimmer, memory dimmer, long press fade, double tap and many other configurations; ○ Powerful enable/disable rules; ○ Support for multiple Zones - being collections of DALI Groups and/or DALI Short Addresses; ○ Supports DALI and RAPIX Scenes.
Typical Applications	<p>High ceiling areas, typically in Atriums, Warehouses, Commercial buildings, Hotels, Health care facilities, Education facilities.</p>

DALI System Commissioning

This product is set up using any DALI-2 commissioning software that supports DALI-2 Control Device instance types 1, 3 and 4. For the higher resilience of RAPIX and to use the built-in Application Controller, the free *RAPIX Addressing* or *RAPIX Integrator* software should be used.

DALI-2 Instances

This product has 3 instances:

Instance 0	Type 4 Light Level
Instance 1	Type 3 Occupancy Sensor
Instance 2	Type 1 Push Button

Instance 2 is always present. If no external switch is connected, then instance 2 will not generate events and will read as 'not pressed'.

Auxiliary Input

By default, the auxiliary input is defined as a DALI-2 Push Button Switch (Instance Type 1). This input can also function as Instance Type 2 (Absolute input) and Instance Type 3 (Occupancy Sensor). DALI commands can change the Instance Type of the Auxiliary Input.

RAPIX Commissioning software uses a Template programming system which automatically selects the appropriate instance type for the selected function.

RAPIX Zero-Commissioning

This product supports RAPIX Zero-Commissioning. If there is no setup by DALI-2 or RAPIX Software, then:

- The switch input transmits DALI Broadcast On/Off/Fade; and
- If desired, the occupancy sensor can be enabled to operate as a 15 minute occupancy function, which transmits DALI broadcast On/Off. When used for this function, the OFF operation of the switch input allows an exit delay.

Easy-Check

Unprogrammed sensors are easily located: A green indicator behind the lens is illuminated when the occupancy sensor has no setup, and RAPIX Zero-Commissioning has not been activated.

Typical Detection Range

3 m mounting height

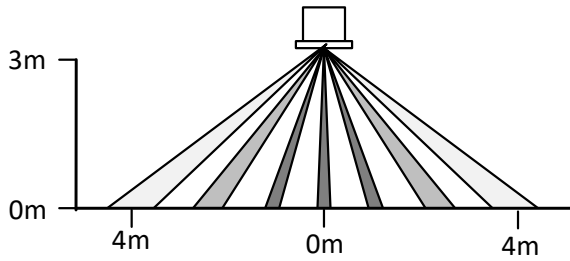

6 m mounting height

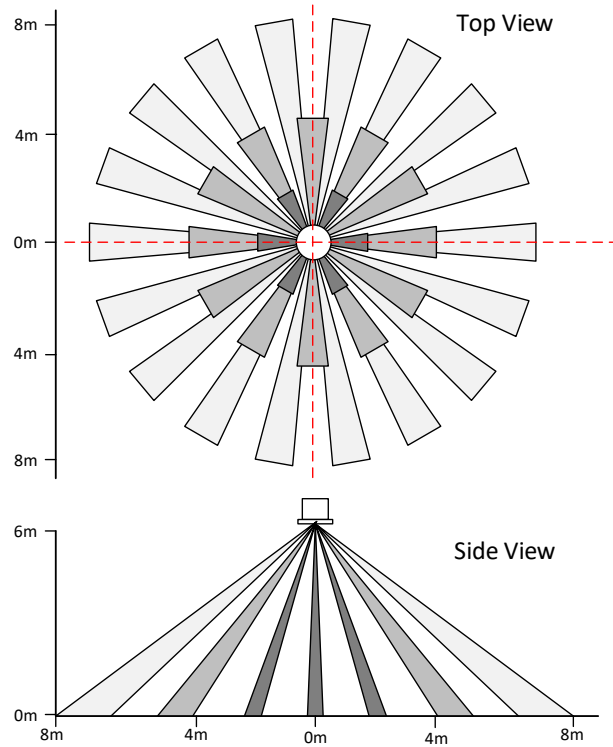

10 m mounting height

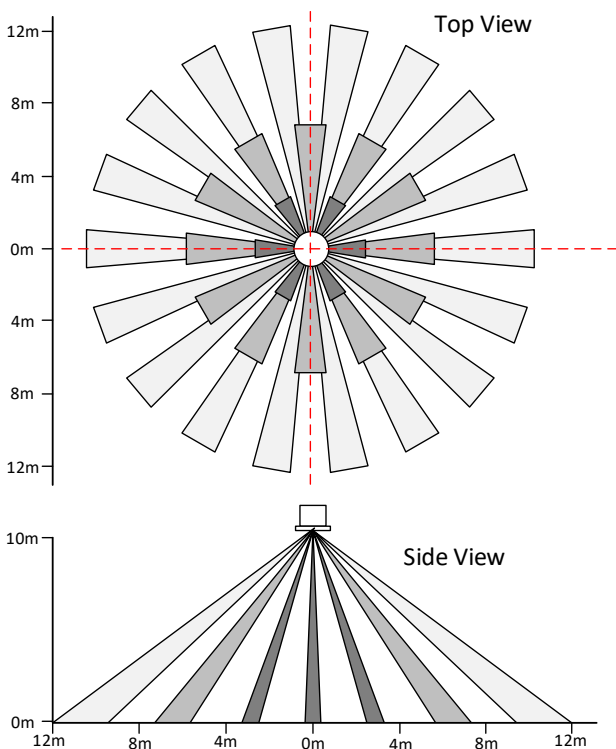



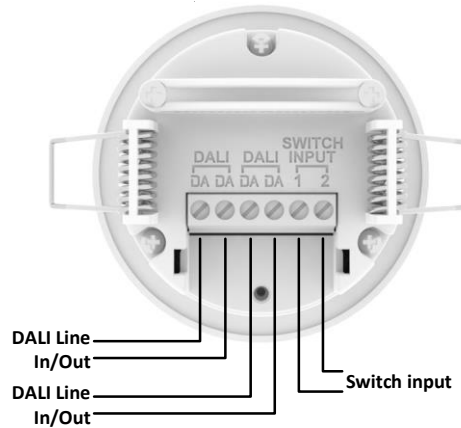



Connections



Specifications: RAPIX DALI-2 Long Range Occupancy and Light Level Sensor

Parameter	Specification
Detection range (diameter)	Up to 24 metres for 10 m mounting height. See diagrams for typical cases.
Recommended mounting height	6 to 12 metres
Maximum mounting height	16 metres
Light Level Measurement range	0 – 1023 lux (default) DALI Operating Mode allows optional high range: 0 – 65000 lux
Power source	DALI Line
Compatibility	DALI and DALI-2
DALI Line operating voltage	16 V dc (nominal), operation from 9.5 V – 22.5 V
DALI Line current draw	2 mA (nominal), 4 mA (peak)
Start up time	< 1.2 seconds
Mains tolerance	DALI input and auxiliary input are mains voltage tolerant
DALI connection	4 Tunnel Terminal block Each tunnel suitable for 1 x 2.5 mm ² or 2 x 1.5 mm ² wires
Auxiliary connection	2 Tunnel Terminal block Each tunnel suitable for 1 x 2.5 mm ² or 2 x 1.5 mm ² wires
Maximum auxiliary cable length	25 m when using twin core mains cable ≥ 0.75 mm ² wires
Auxiliary Input Types	DALI-2 Type 1 (Push button switch), Type 2 (Absolute / toggle switch) or Type 3 (voltage free contacts of an occupancy sensor).
Indicators	Identification: Green, front through sensor lens
Ambient operating temperature	-20 to 50° C
Ambient storage temperature	-40 to 70° C
Humidity	0% to 95% RH non-condensing
Ingress protection	IP20
Materials	Enclosure – UV stabilised flame-retardant polycarbonate, UL 94V-0
Weight	105 g
DALI addresses used	One DALI-2 Control Device Short Address, no Control Gear Short Addresses
DALI Addressing types supported	Short Addresses, Group Addresses, Scenes, Broadcast
RAPIX Application Controller DALI addressing types supported	Control Gear Short Addresses, Group Addresses, Scenes, Broadcast
Additional addressing types	RAPIX Zones, RAPIX Flags, RAPIX Operating Properties

Parameter	Specification
Approvals	     

Specifications: Surface Mount Adaptor – available separately

Parameter	Specification
Mounting Centres	Screw, 50 mm and 60 mm spacings
Material	Flame retardant Polycarbonate
Order Code	White: DGOZ-SEN-SMH

Specifications: Field of View Mask – available separately

Parameter	Specification
Material	Flame retardant Polycarbonate
Order Code	White: DGOZ-SEN-FOV

Standards & Compliance
EMC and Electrical Safety Frameworks and Standards

IEC/EN 55015, AS/NZS CISPR 15, AS CISPR 15
 EN 55032, AS/NZS CISPR32
 EN 55035
 EN 61547
 EN 61347-2-11, AS/NZS 61347.2.11
 EN 61347-1, AS/NZS 61347.1
 EN 62368-1

DALI Standards and Compliance

IEC 62386-101 Ed 2 (DALI-2)
 IEC 62386-103 (DALI-2 Control Devices)
 IEC 62386-301, -303, -304 (DALI-2 Instance Types Push Button, Occupancy Sensor, Light Level Sensor)
 IEC 62386-302 (DALI-2 Instance Absolute, tested, not certified)

EC Council Directives

2014/35/EU Low Voltage
 2014/30/EU Electromagnetic Compatibility (EMC)
 2015/863 Restriction of Hazardous Substances (RoHS) in Electrical and Electronic Equipment

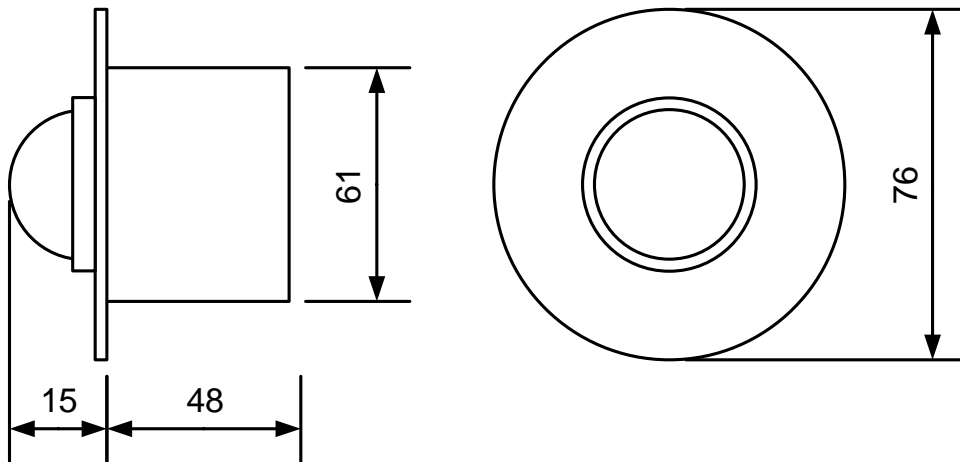
Dimensions**Contact Information**

Web www.ozuno.com
All Enquiries +61 8 8362 7584 sales@ozuno.com

Ozuno Trading Pty Ltd

ABN: 96 621 194 483

This product includes a **TWO-YEAR WARRANTY** against manufacturing defects.

RAPIX is a trademark of Ozuno Holdings Pty Ltd.

DALI and **DALI-2** are trademarks of the Digital Illumination Interface Alliance.

COPYRIGHT © 2019-2024 This document is copyright by Ozuno Holdings Pty Ltd. Except as permitted under relevant law, no part of this data sheet may be reproduced by any process without written permission of and acknowledgement to Ozuno.

DISCLAIMER. Ozuno Holdings Pty Ltd (Ozuno) reserves the right to alter the specifications, designs or other features of any items and to discontinue any items at any time without notice and without liability. While every effort is made to ensure that all information in this Data Sheet is correct, no warranty of accuracy is given and Ozuno shall not be liable for any error.

TRADEMARKS. The identified trademarks and copyrights are the property of Ozuno Holdings Pty Ltd unless otherwise noted.

13-20-504-001-06 December 2024